

Columbia Boiler Waste Oil-Fired Boiler Owner's Manual

LVWO Waste Oil Boiler

All Installations Must Be In Accordance With State and Local Codes and it is the responsibility of the installer to assure all codes are met

For service, call your dealer or installer at

or Columbia Boiler Company at 610-323-2700 to find the distributor for your area

Date Installed: _____

WARRANTY NOTICE

**Use of equipment not manufactured or designed for use by Columbia Boiler Company,
VOIDS the warranty - property or personal damage could occur.**

Columbia Boiler Company

TABLE OF CONTENTS

SUBJECT	PAGE
PACKING LIST	3
SYSTEM INSTALLATION	4
BURNER, PUMP AND CHIMNEY	6
BURNER COMPONENTS	8
AIR AND OIL SUPPLY	11
ELECTRICAL	13
WIRING DIAGRAMS	14
START-UP	17
FINE TUNING THE BURNER	18
PRIMARY CONTROL FUNCTIONS	19
BURNER MAINTENANCE	20
BOILER MAINTENANCE	27
PRODUCT SPECIFICATIONS	32
BOILER ROOM REQUIREMENTS	34
BOILER CONTROLS	36
TROUBLE SHOOTING	39
PARTS LIST	41
APPENDIX A: Boiler Piping Diagram	
APPENDIX B: Aquastat Control Instructions	
WARRANTY	

PACKING LIST

All units should be inspected for damage upon arrival. Concealed damage claims should be filed immediately with the carrier by the consignee. The carrier is responsible for taking prompt action on all claims.

1 Boiler / B-5 Burner and Burner Cord

1 Stainless Steel Chamber Liner (Installed)

1 Temp/Pressure Gage (Mounted)

1 ASME Relief Valve

1 Operating Aquastat / 1 High Limit Aquastat (Mounted)

1 Boiler Manual

1 Boiler tube brush

1 Oil Pump

1 Pump / Filter Kit

1 Tank Suction Strainer

1 Filter with Vac / Air Gage

1 Vac / Air Gage

1 of each: 3/4X1/2 FPT Swivel, 1/4 X 1/4 X 1/8, Tee, 1/4 NPT Hex Nipple, 1/4 Nipple, 1/2 Nipple, 3/4 Check Valve, 3/4 Shut Off Valve

1 Junction Box with Cover and Terminal Strip

SYSTEM INSTALLATION PROCEDURE

- 1) Select a location for your boiler observing minimum clearance to combustibles. See “Boiler Room Requirements” in this manual. Consider that maintenance and cleaning will be required. Allow adequate work space around burner and stack. Three feet of clearance on around all surfaces is recommended.
- 2) Mount boiler on a non-combustible level surface and observe minimum clearances to combustibles. Elevating the boiler on non-combustible blocks will make maintenance easier. For clearances less than listed below, consult NFPA-31.

Minimum Clearance to combustible Materials

Sides: 2”

Rear: 2” (Allow clearance to remove rear door for cleaning, approx. 18 in.)

Front: 12” (Allow clearance to open swing door for cleaning, approx. 22 in.)

Chimney Connector: 6”

- 3) See the piping layout diagram (Appendix A.) for suggested piping arrangement. The boiler is equipped with a built in air scoop. This feature allows quiet air free operation of your hot water system by assuring removal of air pockets without the use of Air Scoop devices. The 1 ¼” supply fitting on the top of the boiler extends approximately 1” below the top of the boiler, thus allowing only air-free water to enter the supply. An Automatic Float Vent, provided by others, must be installed on the ¾” vent tapping, as shown in the piping diagram to vent trapped air.
- 4) For best operation minimize distance of horizontal chimney runs. Do not exceed 8' in length. Horizontal runs must have a 1/4" rise per foot. Clean horizontal runs every 500 hours of use or as needed. Ash will accumulate here and block draft. Poor draft causes poor flame, backpressure, oily buildup, unreliable ignition.
- 5) **WASTE OIL BOILERS ARE DEPENDENT ON PROPER DRAFT FOR EFFICIENT BURNING. ASSURE THAT ADEQUATE MAKE-UP AIR IS AVAILABLE. NEGATIVE DRAFT REQUIREMENT: -.04 to -.06 IN. OF WATER COLUMN BETWEEN THE BOILER OUTLET AND THE DRAFT REGULATOR AND APPROX -.02 OVER THE FIRE. BUILDING EXHAUST FANS OR COLD BUILDING TEMPS. AT NIGHT CAN REVERSE YOUR DRAFT AND CAUSE FUMES, POOR COMBUSTION, OR BURNER LOCKOUTS. TAKE MEASURES TO ASSURE BOILER WILL HAVE PROPER DRAFT DIRECTION WHEN OPERATING.**
- 6) **CHECK DRAFT AFTER START-UP AND STEADY STATE. THEN CHECK BY OPENING DOORS AND STARTING VENT FANS TO ASSURE THAT DRAFT REGULATOR CAN MAINTAIN -.04 TO -.06 UNDER ALL CONDITIONS. A SECOND REGULATOR MAY BE NEEDED IF DRAFT CAN NOT BE MAINTAINED. A DRAFT REGULATOR IS REQUIRED ON ALL INSTALLATIONS. A DRAFT INDUCER IS RECOMMENDED WHEN THERE IS INSUFFICIENT DRAFT.**

- 7) If permanent masonry chimney is not available, use appropriate diameter multi-wall manufactured chimney and collars listed for use with oil fired boilers per UL 103 or All Fuel Class A. Locate for easy connection to the boiler and install per manufacturers' instructions and local building and fire codes. Proper burner settings and normal operation will produce a gross chimney temperature between 400°F and 600°F.
- 8) **The chimney must extend a minimum of 3' above the highest roof line within 10'. In general you will need a minimum of 2 feet of vertical for each foot of horizontal for best draft.**
- 9) Use a stack that is equal diameter to the boiler outlet (5 in.). Use minimum 24 gauge single wall connector pipe between boiler outlet and damper. Do not allow rain to come down the chimney and have a path into fire chamber. This will create an environment that will promote rust. Install a chimney tee near the boiler to act as a cleanout / water trap.
- 10) **Locate barometric damper (draft regulator) near the boiler. Its opening must be visible from the floor and out of strong airflows that could falsely affect its ability to regulate.**
- 10) Adequate air must be provided for combustion and ventilation. In buildings of tight construction, you should provide an opening connected to a well ventilated space, or the outdoors. The opening should have a free area of 1 square inch per 1,000 Btu per hour for all appliances located in the space. Boilers installed in confined spaces should have two ventilation openings each with a free area of 1 square inch per 1,000 Btu per hour for all confined appliances. One opening should be near the top of the space and the other near the bottom. An air boot kit is available from your Columbia dealer for outside air.
- 11) The LV Waste Oil Boiler is equipped with a hinged burner swing open door. The door is installed to open from the right to the left. **Take care to install all wiring, fuel and air lines so that the door can be opened without disturbing the lines.** See Burner section in this manual for installation information.

IMPORTANT

The hinged burner door is opened by removing the six 3/8" brass nuts located on the top, bottom and right side of the door. The two brass nuts located on the left side hold the door to the hinge. Do not loosen or remove the brass nuts holding the door to the hinge after the burner is installed.

BURNER , PUMP, & CHIMNEY

PUMP SPECIFICATIONS

'A' Pump		'J' Pump
1/4 " FNPT	Inlet Port	1/2 " FNPT
1/8 " FNPT	Outlet Port	1/4 " FNPT
40-60 PSI	Pressure Range	20-40 PSI
6 GPH	Max. Flow	18 GPH
1725 RPM	Speed	1725 RPM
1/4	HP	1/4
CW Shaft End	Rotation	CW Shaft End
20" Hg	Max Operating Vacuum	20" Hg
10' Vertical	Maximum Suggested Lift	10' Vertical
3/4" pipe	Horizontal Suction Piping < 30 Ft.	3/4" pipe
1" pipe	Horizontal Suction Piping > 30 Ft.	1" pipe

INTRODUCTION

Purchase of a Columbia multi-oil burner is a wise investment. To maximize the return on this investment you must read and save this manual. It contains installation instructions, diagnostic procedures, burner cleaning, maintenance procedures and parts ordering information. Follow the installation instructions carefully.

You can expect years of reliable performance with a properly installed and maintained system.

THIS BURNER IS NOT INTENDED FOR RESIDENTIAL USE.

It shall be installed only by a qualified installer who is engaged in, responsible for or thoroughly familiar with the permitting, installation and operation of oil-fired appliances; who is experienced in such work and is familiar with the precautions required; and who will comply with all the requirements of the Authority having jurisdiction over the installation.

The installation of equipment in the United States must consider the requirements of the following publications of the National Fire Protection Association, Battery March Park, Quincy, Massachusetts 02269:

N.F.P.A.	No. 30	Flammable and Combustible Liquid Codes
N.F.P.A.	No. 31	Standard for Installation of Oil Burning Equipment
N.F.P.A.	No. 88A	Standard for Parking Structures
N.F.P.A.	No. 88B	Standard for Repair Garages
N.F.P.A.	No. 211	Standard for Chimney, Fireplaces, Vents and Solid Fuel Burning Appliances

The installation of Equipment in Canada must consider the requirements of C.S.A., Standard B 139, Installation Code for Oil Burning Equipment.

This burner is recommend for burning #1 & #2 fuel oil, used motor oil, automatic transmission fluid, hydraulic oil, vegetable oil and gear oil mixed not to exceed SAE 50. Such oils may contain gasoline and specific precautions on the handling and storage of waste oils are to be observed.

Do Not add to oil supply or burn: unknown garbage oils, gasoline, naphtha, chlorinated cleaning solvents or oil additives in this boiler. It is normal to experience operating problems such as plugged nozzles, suction line leaks, etc. during the first few weeks of use. Follow start-up instructions for purging fuel and air lines to help avoid these problems.

BURNER COMPONENTS IDENTIFICATION

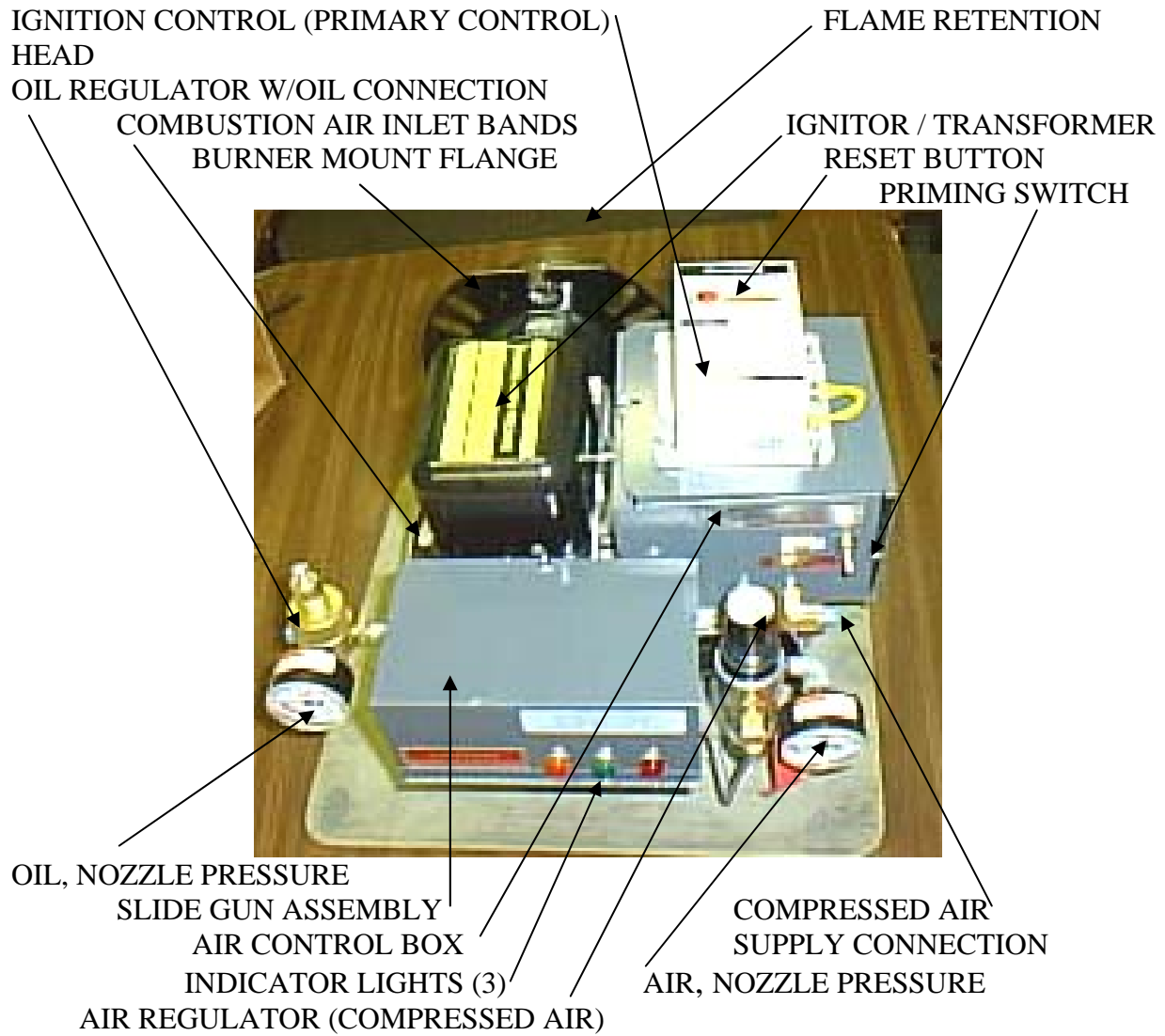

FIELD ASSEMBLY INSTRUCTIONS - BURNER

1/8" end nozzle to end electrode

Upper fins are open to allow light to cad cell

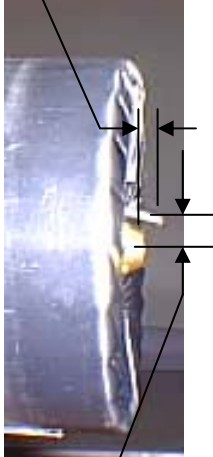

7/16" center of nozzle to electrode

5/32" closest gap

1) PRIOR TO INSTALLING BURNER, CHECK FOR SHIPPING DAMAGE TO FLAME RETENTION HEAD AND IGNITION ELECTRODE ALIGNMENT.

- 2) If components are not as shown you can make adjustments to the electrodes by removing the hole plug on top of burner tube near mount flange. With screw driver, loosen the screw holding the electrode clamping plate. Adjust electrodes as shown. Re-tighten clamp screw. Do not over tighten or insulation on electrodes may crack. Examine electrode position after tightening to be sure position has not changed. Replace hole plug.
- 3) The electrodes should not touch surrounding metal parts or be within 3/16" as they will short the arc and not light the oil spray.
- 4) Attach burner to boiler. Grasp burner by the mount flange and motor, slip burner flange over studs on hinged burner door and secure with nuts and washers.

INSTALLATION OF CHIMNEY SYSTEM

INSTALL CHIMNEY TO FLUE COLLAR OF BOILER

For best operation minimize distance of horizontal chimney runs. Do not exceed 8' in length. Horizontal runs must have a 1/4" rise per foot. Clean horizontal runs every 500 hours of use or as needed. Ash will accumulate here and block draft. Poor draft causes poor flame, backpressure, oily buildup, and unreliable ignition.

WASTE OIL BOILERS ARE DEPENDENT ON PROPER DRAFT FOR EFFICIENT BURNING. ASSURE THAT ADEQUATE MAKE-UP AIR IS AVAILABLE. NEGATIVE DRAFT REQUIREMENT: -.04 to -.06 IN. OF WATER COLUMN BETWEEN THE BOILER OUTLET AND THE DRAFT REGULATOR AND APPROX -.02 OVER THE FIRE. BUILDING EXHAUST FANS OR COLD BUILDING TEMPS. AT NIGHT CAN REVERSE YOUR DRAFT AND CAUSE FUMES, POOR COMBUSTION, OR BURNER LOCKOUTS. TAKE MEASURES TO ASSURE BOILER WILL HAVE PROPER DRAFT DIRECTION WHEN OPERATING. A DRAFT REGULATOR IS REQUIRED. A DRAFT INDUCER IS RECOMMENDED WHEN THERE IS INSUFFICIENT DRAFT.

If permanent masonry chimney is not available, use appropriate diameter multi-wall manufactured chimney and collars listed for use with oil fired boilers per UL 103 or All Fuel Class A. Locate for easy connection to the boiler and install per manufacturers' instructions and local building and fire codes. Proper burner settings and normal operation will produce a gross chimney temperature between 400°F and 600°F with a clean boiler.

The chimney must extend a minimum of 3' above the highest roof line within 10'. In general you will need a minimum of 2 feet of vertical for each foot of horizontal flue for best draft.

Use a stack that is equal diameter to the boiler outlet (5-in.). Use minimum 24-gauge single wall connector pipe between boiler outlet and damper. Do not allow rain to come down the chimney and have a path into fire chamber.

If necessary, a draft inducer should be used to provide adequate draft conditions and should be placed as near the building flu exit as possible. Inducers will pull air better than push it. Smaller inducers will not be adequate in some chimney installations. A draft regulator must be used in conjunction with a draft inducer.

- **Confirm local building codes will allow inducers**
- **Locate inducer as close to where chimney exits building as practical**
- **Never allow rain or condensation to flow back into boiler**
- **Place a screen (1/2" or 3/4" openings) over stack to keep animals out**
- **Observe clearance to combustible materials**

COMPRESSED AIR SUPPLY

1. A minimum 2 CFM at 40 psi is needed into the burner. Use a hydraulic quick disconnect or put ample flex in the line to swing burner open when servicing. A dedicated air compressor at the boiler in lieu of using the shop's air system is acceptable. A compressor of $\frac{3}{4}$ to $1\frac{1}{2}$ HP is typical. Consult Columbia Boiler or your installer for models available. Drain all compressors frequently to help keep moisture from entering burner.
2. Many burner service problems are from "rusty" air causing burner components to fail. It is wise to use a oiler and/or regulator to treat & reduce air pressure entering the burner to approximately 60 psi. Wear on burner parts will be reduced and ignition more reliable. Providing a drip leg with valve near the burner to trap water, scale, and rust is recommended. If water is present take all measures to remove it. The air solenoid may stick and other components may rust and fail.
3. **SERVICE TIP:** 80% of service problems can be avoided by keeping contaminants like rust chips, water, pipe dope, insects from reaching burner through the air and oil lines.

OIL PUMP MOUNTING

1. Consult your dealer for best plumbing methods before starting. Mount the pump as near the oil supply tank as possible. You may mount the pump above the tank to suction lift oil to the pump or another option is to place the pump below the tank level to gravity feed or siphon oil to the pump. Do not exceed 10 psi into the pump inlet in any arrangement or the seal may leak. Allow space for service. Be sure to meet all building and fire code requirements.
2. Any pump/motor orientation is acceptable as long as the pump shaft is horizontal. You may rotate the pump head on the mount to simplify plumbing connections. Be sure the motor and pump shafts are aligned and coupling set screws are tight before operating.



Above Tank Mount



Below Tank Level Mount

FINISHING THE PLUMBING.....

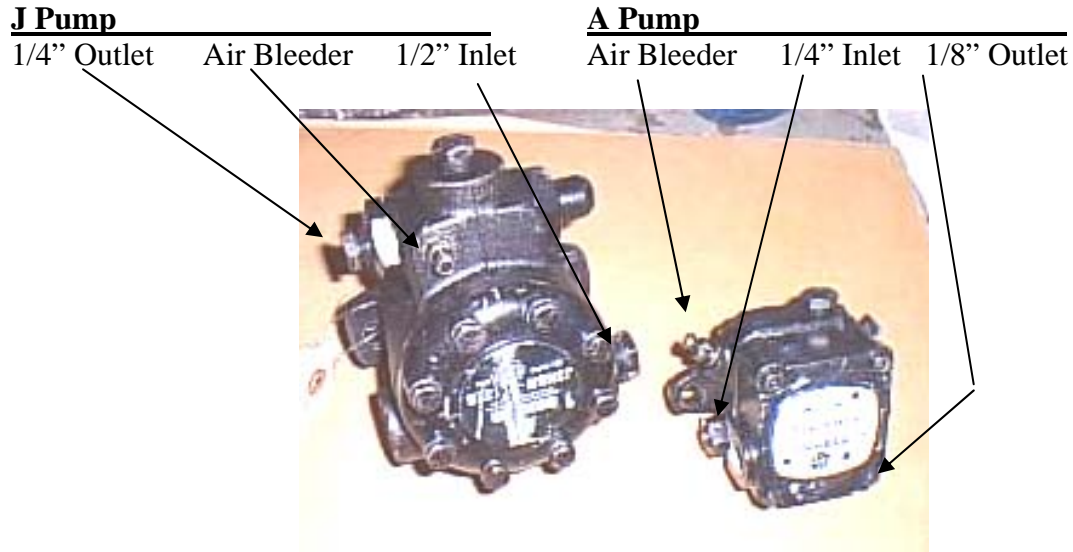

[If Using a CDVF Pump follow instructions in CDVF Manual]

Consult your dealer for the best plumbing arrangement for your boiler. There are many ways the plumbing can be done. **Use pipe dope on threads, not tape !** Flared tubing & fittings are acceptable, never use compression fittings ! Meeting building codes and your needs may require deviation from the fittings provided in your accessory carton and described in the example below. Components shown are provided with standard purchases and found in Accessory Carton. **Note:** Some J pumps will have dual 1/2 " inlets. Pipe to only one inlet.

3/4 FPT Filter Tee Gauges 3/4x1/2 Swivel 1/2 Nipple Pump 1/4 Nipple 1/4x1/4x1/8 Tee

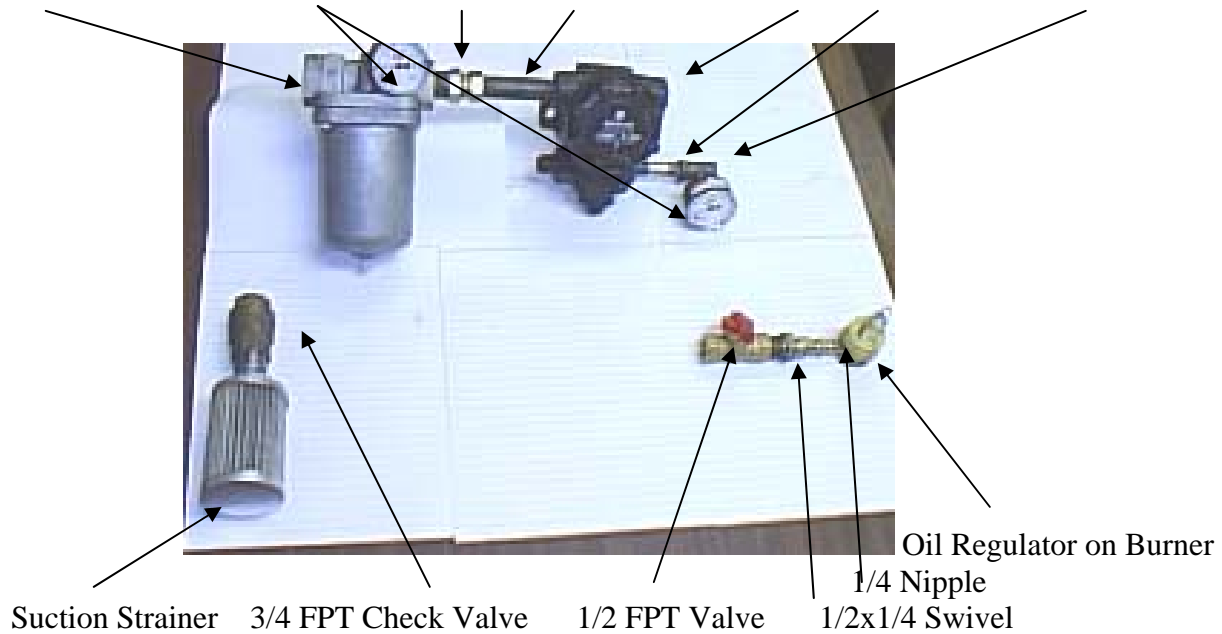

Suction Line: Field provides piping from Check Valve to Filter. Secure piping to keep the Strainer 6" off the bottom of the tank. Plan ahead for routine service of components. Use minimal number of fitting to reduce chances of suction leaks. Note: Some J Pumps have dual suction ports. It is only necessary to pipe to one of these ½ inches ports.

Pressure Line (Oil Pump Outlet): After the provided Nipple/Tee/Gauge the field provides tubing or piping to reach from the 1/4 Tee to the 1/2 Valve near the Burner. A 3/8 inch or 1/2 inch FLARED (never use compression) soft copper tubing is commonly used. Hard metal tubing or metal pipe is acceptable but may incur more cost, has more potential for leaks, and is not flexible to swing the burner open for routine cleaning

Try to run the oil piping uphill from the pump to the burner to allow entrapped air to escape at the burner. Avoid high spots in the oil piping or looping the line above the burner as this creates a trap and collects air. Collected air will delay the oil getting to the nozzle, causing a weak flame, slow or failed ignition, or pressure gauge and flame pulsation.

[TIP: Spiral or loop some excess tubing at the burner to allow the burner door to swing open w/o having to disconnect the oil line tubing.

Do not connect oil line to valve at the burner until after the oil line is purged of dirt and air.

[Suggestion: to ease future oil line purges, adding a tee and drain cock near the burner allows dirt and air to be purged without disconnecting the line from the burner.]

ELECTRICAL CONNECTIONS

All electrical wiring must meet National Electrical Code, N.F.P.A. #70 for BOILERS installed in U.S., and C.S.A. Standard C22.1, Canadian Electrical Code, Part 1, for Canada.

Install a panel mounted breaker for single phase 115V 15 AMP grounded service. Run minimum of 12 gauge wire in metal conduit. Do this with the power still "OFF". TIP: If the main 15 amp breaker is far from the burner, installing a manual switch or breaker near the burner may be required by code. It is also handy for cutting main power in an emergency or for servicing.

The burner cord has four wires: Black is power to burner. White is neutral. Red is power out from burner to oil pump or accessories. Maximum 10 amps total load. Green is ground.

***Be sure to wire burner and controls so that the burner always has power. This allows the heating elements to keep the block warm and ready for the next start up. WIRE OPERATING AQUASTAT TO T-T TERMINALS ON THE BURNER.**

For field wiring of oil pump and accessories, use minimum 16 gauge wiring.

B5 SINGLE NOZZLE BURNER INTERNAL WIRING

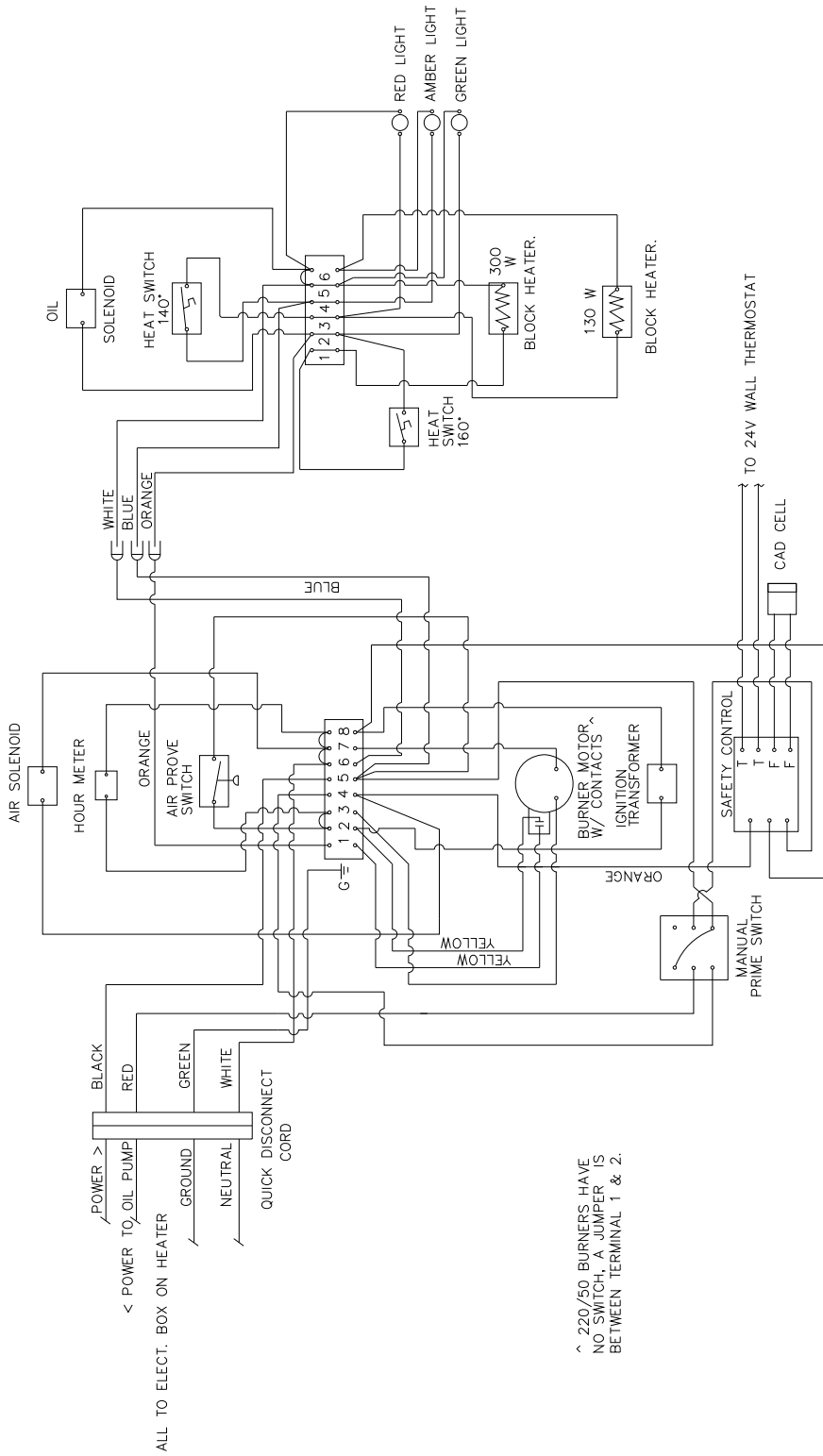

MODEL B5 BURNER WIRING (120/60, 220/50)

henandoah Manufacturing Company
HARRISONBURG, VIRGINIA

DATE	01-19-99	CHECKED BY	
DRAWN BY	Kevin Clemmer	APPROVED BY	
DRAWING NO.	A-51001168		
REV	1	SHEET	1 OF 2

NOTE: THIS DRAWING (OR PRINT) IS THE PROPERTY OF HENANDOAH MANUFACTURING COMPANY, HARRISONBURG, VA. AND SHALL NOT BE REPRODUCED, COPIED, TRACED, PHOTOGRAPHED, PHOTOSTATED OR REPRODUCED IN ANY MANNER, NOR USED FOR ANY PURPOSE WHATSOEVER, EXCEPT BY WRITTEN PERMISSION OF HENANDOAH MFG. CO.

LTR	REVISION	DATE	BY

B5 SINGLE NOZZLE BURNER INTERNAL WIRING

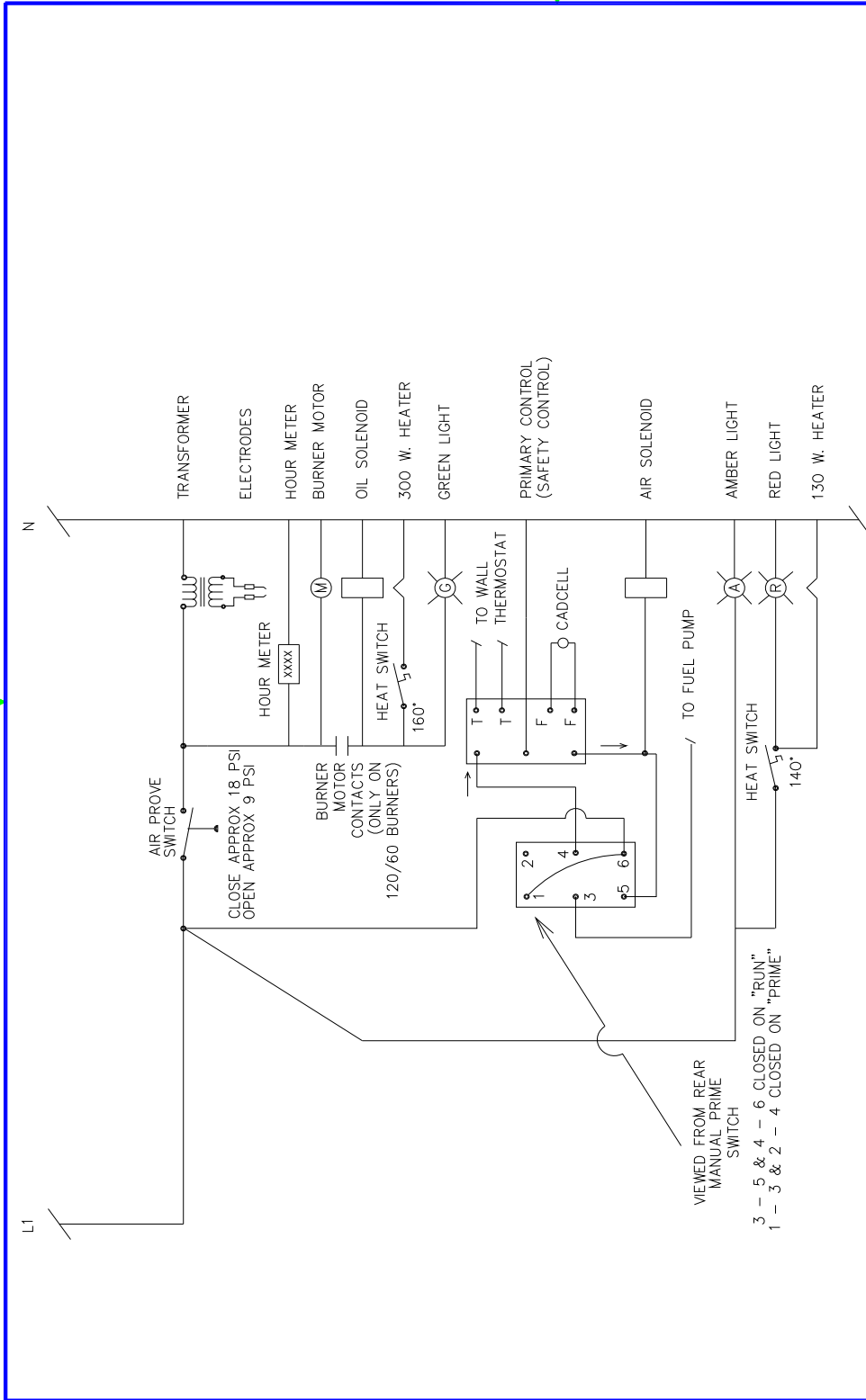

MODEL B5 BURNER DIAGRAM (120/60 & 220/50)

DATE 01-19-99 CHECKED BY

DRAWN BY Kevin Clemmer APPROVED BY

DRAWING NO. REV SHEET 2 OF 2

A-51001168

Shenandoah Manufacturing Company
HARRISONBURG, VIRGINIA

NOTE: THIS DRAWING (OR PRINT) IS THE PROPERTY OF THE SHENANDOAH MFG. CO., HARRISONBURG, VA., AND SHALL NOT BE TRACED, PHOTOGRAPHED, PHOTOSTATED OR REPRODUCED IN ANY MANNER, NOR USED FOR ANY PURPOSE WHATSOEVER EXCEPT BY WRITTEN PERMISSION OF SHENANDOAH MFG. CO.

LTR	REVISION	DATE	BY

WIRING BURNER TO BOILER

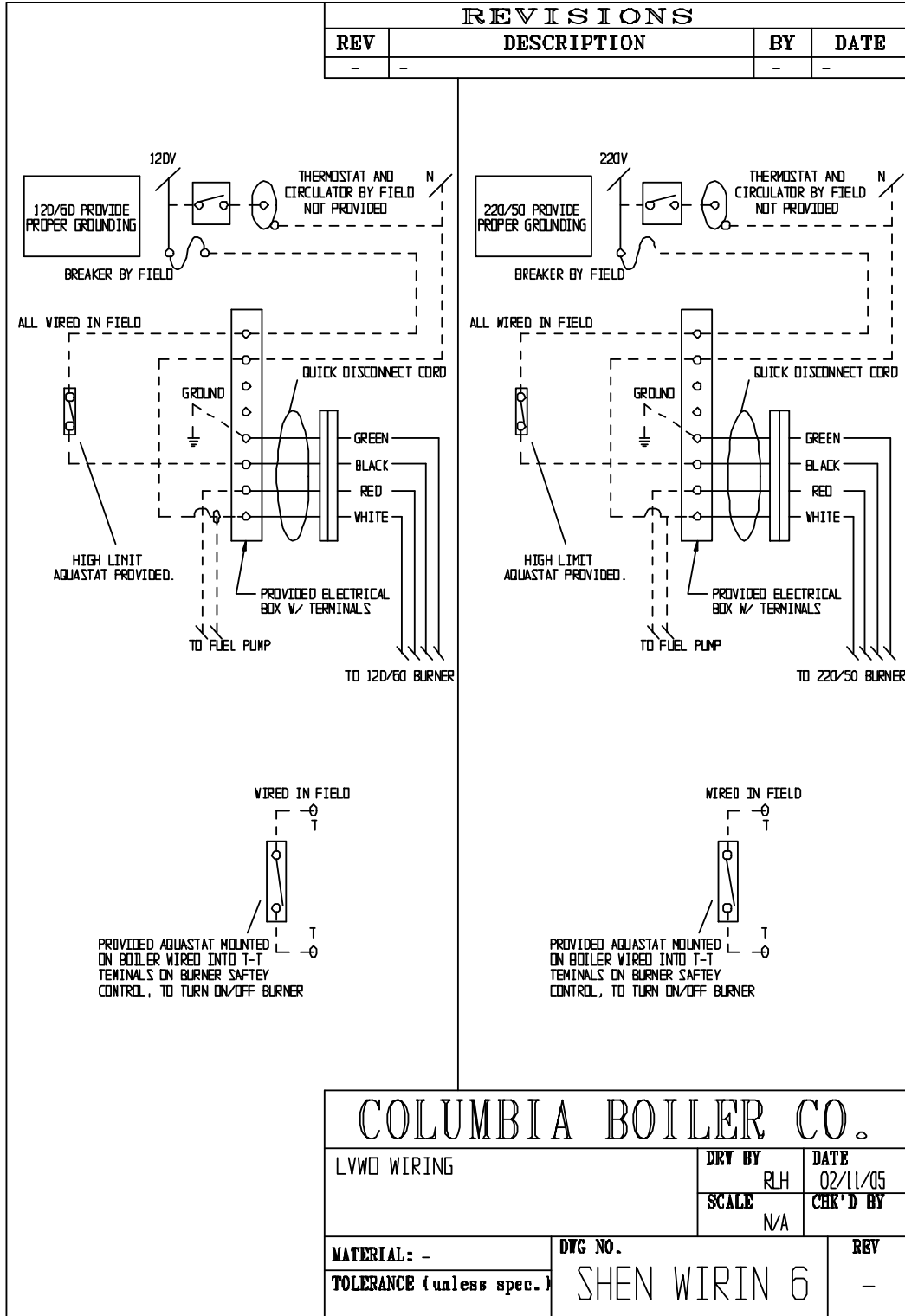

INITIAL START UP AND OPERATING SEQUENCE

1. Place the 3-position toggle switch on the Burner to “OFF”. Energize the boiler circuit with electricity. The amber and red lights on the slide gun will come on. Flip the 3-position toggle switch on the Burner to “PRIME”. The pump will start. Open the bleed valve on the pump to relieve air, have a bucket ready to catch oil. After a few minutes, there will be oil and air sputtering from the bleeder. Close the bleeder when oil runs free of air. Oil will now start filling the line to the burner.
2. Before the oil line is attached to the burner, have a bucket ready to catch oil, but be patient. It may take 20 minutes to prime the pump and get oil to the burner. Minimize wear on pump and time involved by filling oil lines and filters with oil before running pump.
3. Once the line is filled you will start catching the contaminated oil at the burner in your bucket. When the oil is free of air and debris run another few gallons more and close the purge valve or connect the oil line to burner. Flip the 3-position toggle switch on the Burner to “RUN”.
4. By now the red light indicating preheating of the oil may have gone off. If it has, turn the wall thermostat to a setting higher than room temperature. The burner will start.
5. The fuel pump starts and the air solenoid valve opens to allow air into the air tank and air proving switch. When air pressure of 20 psi is achieved in the tank, the air proving switch closes providing power to burner motor and oil solenoid valve. The burner will attempt to fire and the green light comes on indicating the burner is firing.
6. Adjust air pressure regulator on burner to approximately 12-14 psi. The preheated oil and air are mixed at the nozzle and the fuel is atomized as the electrodes arc for ignition. The red light will cycle on/off to automatically maintain air/oil temperature.
7. Adjust oil flow for proper flame size (2-4 psi). Proper flame size will result in a stack temperature of 400°F - 700°F. Gauge pressure is only an indicator. Used oil will have a nozzle pressure that depends on oil type and temperature. Look at fire and adjust if needed. Also, adjust air and oil pressure to to achieve heat transfer that minimizes on/off cycling of the boiler. Once oil pressure has been set, tighten the nut at the base of the adjustment screw to maintain setting.
8. If a consistent flame is not established during the initial 30 seconds the primary control will lockout.

CAUTION

DO NOT attempt to restart the control until the boiler has time to cool down and any unburned oil mist has exited the chamber. Forcing a quick restart can put hot oil on the hot surfaces of the heat exchanger and may cause an explosion hazard, or excessive fire leading to personal or property damage. It is not unusual to lock out one or two times at startup until air and oil have purged through the slide gun.

9. Sequence of operation using the Hi/Low Limit Aquastat provided. When system temperature falls below the thermostat setting, the thermostat calls for heat starting the circulator pump. The burner and circulator continue to operate until the call for heat is satisfied (the thermostat setting is reached) or until boiler temperature reaches the high limit control setting. The high limit should be set around 180 degrees F. If the high limit control setting is reached, the burner shuts off, the circulator continues to operate until the call for heat is satisfied. If the thermostat continues to call for heat after the boiler temperature has dropped a set amount below the high limit setting, the burner will start again and the circulator will continue to run. When the call for heat is satisfied, the power to the ignition system will be interrupted thus causing the burner to shut down and the circulator will stop. The purpose of the low limit is to maintain the boiler at a temperature high enough to minimize condensation of combustion gases in the boiler during periods when heating requirements are low. If the boiler temperature falls to the low limit set point, the burner will start and raise the boiler temperature above the low limit set point. The number of degrees that the temperature is raised above the low limit is determined by the differential set-point. To reduce cycling of the burner, increase the differential temperature.

FINE TUNING THE BURNER

OBSERVE THE FLAME & BURNER CYCLING DAILY. ALLOWING BOILER TO OVER FIRE WILL DESTROY THE HEAT EXCHANGER AND VOID THE WARRANTY. UNDERFIRING MAY LEAD TO CONDENSATION AND RUST THE CHIMNEY OR BOILER.

Due to variations in used oils, the air and oil pressure gauge setting are approximate. Final adjustments need to be made with your specific fuel. Observe the flame pattern through the observation port and make all adjustments while observing the flame and stack temperature.

1. The ideal flame will appear bright yellow/white in color with no visible smoke emitting from the chimney.
2. If the flame appears dull yellow and red in color, it is fuel rich and oxygen starved. Open the air shutter on the side of the burner or reduce oil flow.
3. Combustion air is admitted through the adjustable air bands on the side of the burner. Start with air band closed and #8 for the faceplate. Add just enough air to allow clean combustion. Excess secondary air will reduce efficiency and make ignition more difficult. If you are using a combustion analyzer, target readings are $CO_2 = 7-10$ and $CO < 50$.
4. The draft and the combustion air required for clean burning, smooth ignition, and efficient combustion is proportional to the fuel flow rate. DO NOT exceed -.06 inches water column draft at the breech.

5. The fuel flow rate is controlled by nozzle size and oil pressure. If the flame is not clean or too large with oil pressure less than 2 PSI, replace the nozzle with a smaller orifice, it may have worn-out or a smaller nozzle may work better at slightly higher pressure.
6. Want to measure actual oil flow? Disconnect piping going into pump. Attach a nipple and rubber hose for a suction line. Place the hose in a measured amount of fuel and time consumption of 16 ounces with boiler running. Divide 63,000,000 by the seconds it takes to burn 16 ounces and that is your btu per hour input.

PRIMARY CONTROL FUNCTION - SAFETY LOCKOUT

CAUTION: DO NOT PUSH THE RESET BUTTON IF THE BURNER FAILS AND THE BOILER IS HOT! FORCING A REFIRE AT THIS TIME CAN PUT FUEL INTO THE HOT COMBUSTION CHAMBER AND CAUSE AN EXPLOSION HAZARD.

When the primary control locks out there is a malfunction. **Determine the cause.** The primary control is a safety device similar to a breaker in an electrical circuit. It will lock out when:

1. The cad cell (electronic eye) detects a reduced / dirty flame or no flame for over 30 seconds. A signal measured in ohms is communicated between the cad cell and the primary control. A poor or absent flame produces a high ohm reading. When this signal is > 1500 ohms the control goes into reset. A signal indicating a very good flame is < 500 ohms. A moderate flame would be 500 to 1000 ohms.
2. The cad cell has failed, lens is dirty, or retention head is dirty.
3. The retention head fins are not allowing light to pass to the cad cell.
4. The cad cell receptacle is not making good contact with the cell.
5. The primary control is defective allowing the reset button to pop too easily.

ROUTINE BURNER MAINTENANCE

Weekly Maintenance

A flame inspection mirror is useful for a routine check of the nozzle, ignition, and retention head while the unit is operating.

1. Observe flame--adjust if needed.
2. Check all filters and water traps in the oil and air supply lines. Clean if needed.
3. Check barometric damper draft setting and be sure flap has freedom to move.
4. Inspect chimney integrity at elbows, tees, fire-stops, roof cap.

Be prepared to clean the boiler, burner head area and nozzle every 200 to 500 hours

A properly cleaned & maintained boiler operates efficiently and prevents possible soot fires. A clean flame and good draft will allow longer intervals between cleanings.

Use cleaning brush to clean boiler tubes and the ash rake to clean combustion tube. Remove stack sections as needed to get ash from inside of chimney. Horizontal runs will collect ash and create draft problems if not cleaned regularly.

CAUTION: Used oil may contain heavy metal compounds and foreign materials. When burned, the compounds are deposited in the boiler and chimney. Protective clothing, including gloves, face mask, and respirator must be worn when cleaning is done. All waste materials removed when cleaning the system should be stored in a closed noncombustible container until properly disposed. Do not store rags or cleaning solvent materials near the boiler, this is a fire hazard.

Burner

Clean retention head and igniters. Using a torch to heat retention head and electrode tips can harden the buildup and make removal easier with a brush. Be sure not to damage shape of electrodes or fins.

Remove the nozzle with a 5/8 socket and disassemble it into 3 pieces. Clean thoroughly and reassemble. Be sure small distributor is seated properly in the ferrule or the cap will mash it when screwed on.

Another option to clean the nozzle is to remove the slide gun assembly from the burner.

1. Disconnect aluminum air line from underside of slide gun using 1/2 inch wrench.
2. Disconnect oil line if it is not flexible.
3. Loosen mount screw on left side of burner to free slide gun from housing.
4. Pull slide gun assembly straight back from burner, this disconnects the electrical as it is withdrawn from air box housing. Secure slide gun in vise by capturing the aluminum

block.

5. Remove nozzle and disassemble into three pieces. Clean with solvents and soft cloth. If wear is evident install a new nozzle. Wear may be in the form of burn marks from igniter arcing or abrasion by oil flow that enlarges the orifices.
6. Inspect o-ring; replace if worn, torn or deformed.

Assembly of Nozzle

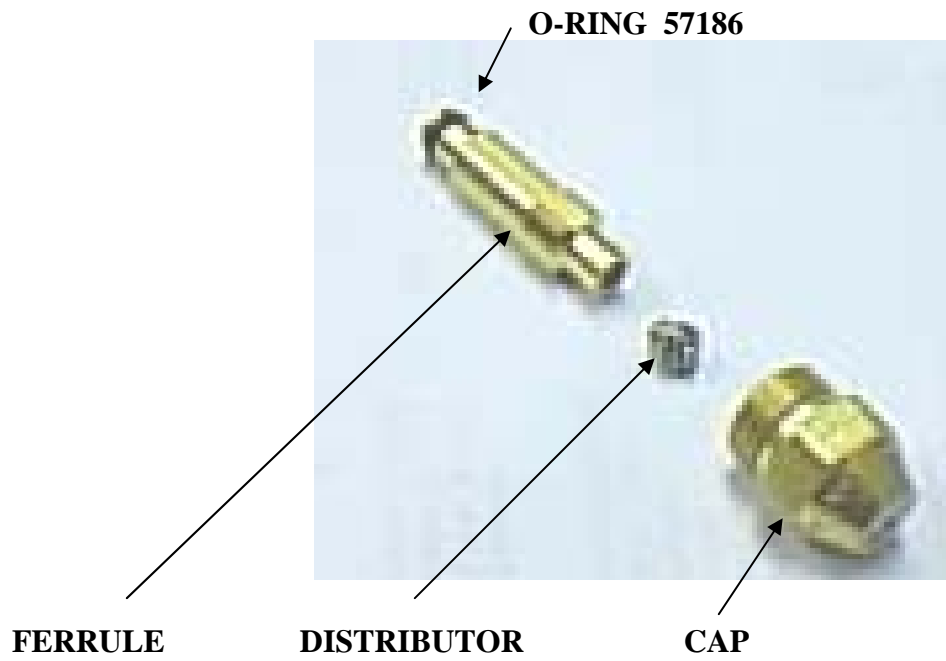

For a more thorough service the following burner components can be cleaned as a preventative yearly maintenance.

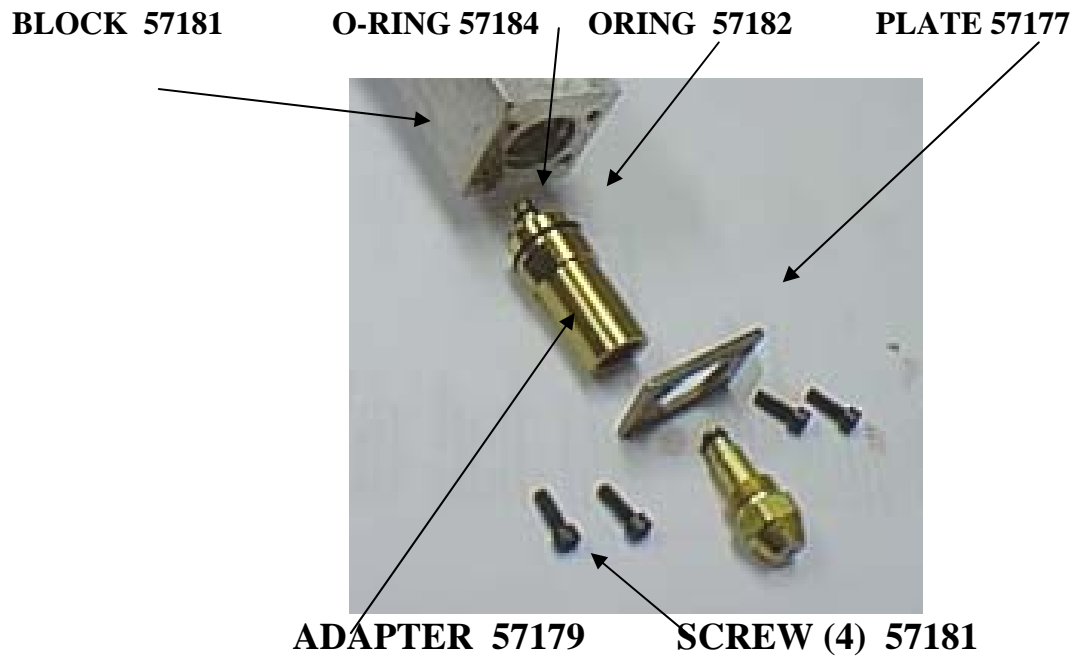

ASSEMBLY OF OIL AND AIR SOLENOID #57190

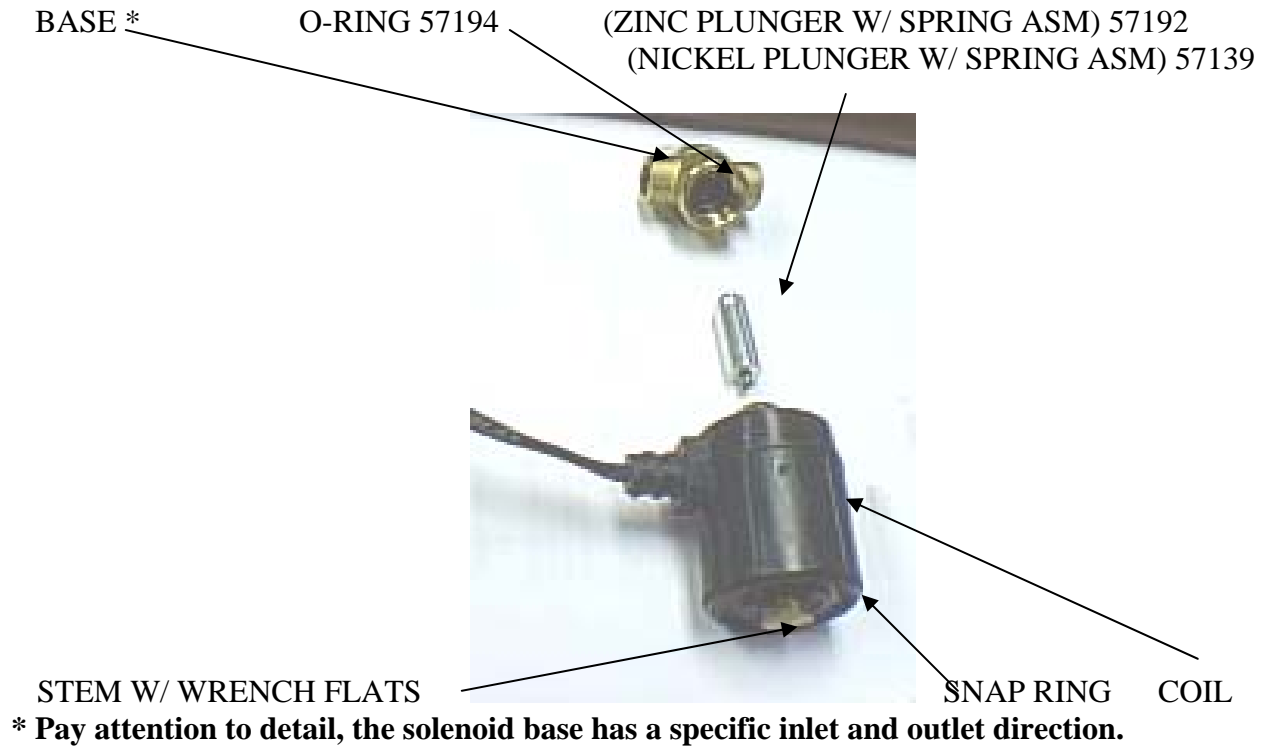

ASSEMBLY OF OIL REGULATOR #57129

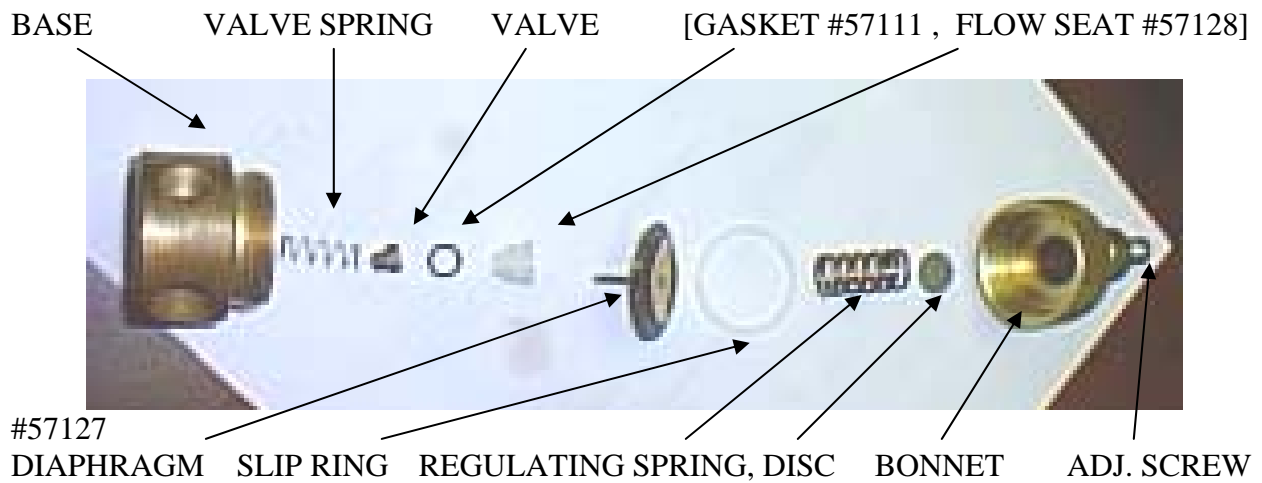

ALUMINUM PREHEAT BLOCK

For a more thorough service the aluminum preheat block can be cleaned. The need to increase oil pressures to maintain a good flame is a indicator block passages may be restricted. How quickly a block becomes restricted varies with hours of use and oil quality. Block cleaning is a skilled service that inexperienced persons should not undertake. Improper methods could damage threads or passageways. Consult your dealer if you think this operation is needed on your burner.

B5 BURNER BLOCK

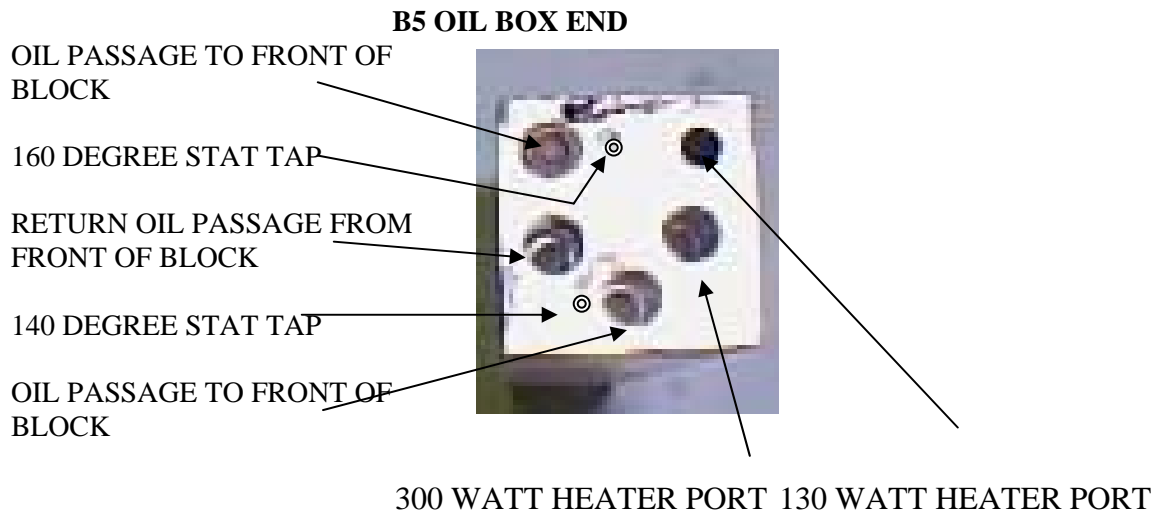
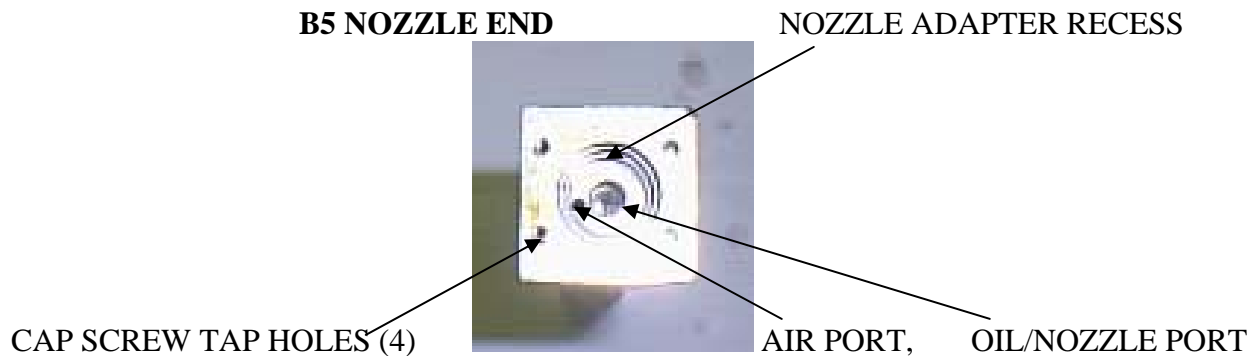

B5 OIL BOX END

OIL FROM SOLENOID INTO
BLOCK AND ON TO NOZZLE

OIL FROM REGULATOR OR
OIL PUMP ENTERS & GOES
TO FRONT OF BLOCK

OIL FROM FRONT OF BLOCK
COMES OUT TO SOLENOID

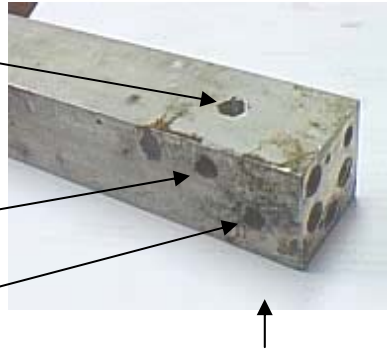

UNDER BLOCK IS TAPPED PORT FOR AIR FROM REGULATOR TO GET INTO BLOCK

CARE AND MAINTENANCE OF YOUR BOILER

At start-up, hot water boilers should be filled with water, vented, and brought to operating temperature to ensure that all air is removed from the system and the boiler. Failure to bring the system to temperature can result in serious system and boiler damage. Read the instructions provided with the automatic vent valve to make sure that air will be vented from the system continuously.

Hot water boilers are subject to serious damage and failure if leaks develop in the hydronic system that requires excessive make-up water. The make-up water introduces high levels of oxygen which will lead to corrosion and component or system failure in a very short time. All boilers and systems should be checked for leaks on a frequent basis. Leaks may be indicated by standing water under or around system components, rust spots or drip spots. On a weekly basis, the system should be checked for hidden leaks. This is done by shutting the make-up water supply isolation valve at a time when the burner is not operating. If pressure on the boiler pressure gage falls, it is an indication that there is a leak in the system which should be located and repaired immediately. Open the make-up water isolation valve after completing the test.

Proper start-up and verifying that hot water boilers are leak free on a weekly basis is adequate to protect the hot water boiler.

System Maintenance

- ❖ Disconnect all incoming electrical power prior to servicing controls, pumps, or burner.
- ❖ Use extreme caution around boiler piping since it may be hot.
- ❖ The life of your boiler can only be measured by the care given to it by those who are charged with the responsibility of boiler maintenance. A log book of the following items should be maintained in the boiler room at all times.

Daily maintenance list

- Check operating pressures of water, oil, and air.
- Check operating temperatures.
- Observe condition of flame.
- Listen for any unusual noises and correct as necessary.

Weekly maintenance list

- Check fuel supply for leaks.
- Observe operation of circulating pump(s).

Monthly boiler check/maintenance list

- Safety relief valve - pull lever and confirm flow escapes.
- Test flame detection devices.
- Test operating and hi-limit controls.
- Check boiler room floor drains for proper operation.
- Inspect combustion air inlets of boiler room.
- Clean ash from inside boiler's heating surfaces and chimney. Frequent cleaning will extend boiler life, ash produces acids harmful to metals and prevents clean combustion.
- Check draft in chimney.
- Check gaskets, and piping for leaks.
- Check tempering valves, expansion tank, and secondary heat exchangers.

Cleaning the Flue Passages

CAUTION

The hinged burner door is opened by removing the six 3/8" brass nuts located on the top, bottom and right side of the door. The two brass nuts located on the left side hold the door to the hinge. Do not loosen or remove the brass nuts holding the door to the hinge when the burner is installed.

CAUTION

Be sure electric power is off to prevent accidental burner firing.

Under normal operating conditions the flue passages will need to be cleaned. If excessive soot has built up on the flue passages they can be cleaned following this procedure.

1. Remove the jacket front cover. Remove six 3/8" brass nuts and flat washers from the front swing-out burner door. **DO NOT REMOVE BRASS NUTS ON HINGE SIDE.** Swing burner door open. Care must be taken when opening the door not to damage the insulating millboard gasket.
2. Remove the jacket rear cover. Remove the rear turn-around cover by removing the eight 3/8" brass nuts and flat washers and pulling the cover off.
3. Place a pan at the rear of the boiler to catch soot. Place a drop cloth or newspaper around the front of the boiler to catch dust when the brush is pulled back through the tubes.
4. Using the tube brush, push the accumulated soot and scale out of the tubes from front to rear. Using the ash rake tool provided, scrape the accumulated soot and scale out of the center furnace tube from front to rear.
5. A vacuum may be used to remove soot and scale left in the front and rear tube sheet areas.
6. Replace the rear cover, washers and nuts. Tighten evenly until cover forms a seal around rear frame.
7. Close the burner door. Install the two 3/8" brass nuts and flat washers on the side of the door and tighten until the other four washers and nuts can be installed. Tighten all of the nuts evenly until a good seal is formed evenly around the door frame.
8. Install the front and rear jacket covers.

Replacing the Burner Swing Door Insulation Board

CAUTION

The hinged burner door is opened by removing the six 3/8" brass nuts located on the top, bottom and right side of the door. The two brass nuts located on the left side hold the door to the hinge. Do not loosen or remove the brass nuts holding the door to the hinge when the burner is installed.

CAUTION

Be sure electric power is off to prevent accidental burner firing.

1. Remove the jacket front cover. Remove six 3/8" brass nuts and flat washers from the swing-out burner door. **DO NOT REMOVE BRASS NUTS ON HINGE SIDE.** Swing burner door open.
2. Remove four 1/4" wing nuts and flat washers from elevator bolts that hold the refractory to the rear of the door. Remove refractory.
3. Position the new refractory on the door, centering the refractory on the burner tube opening. Check that the view port is aligned with the refractory. Check the position of the refractory frequently during installation.
4. Install the four elevator bolts to hold the refractory to the door and install the flat washers and 1/4" wing nuts. Tighten the wing nuts to make them snug while checking the position of the refractory.
5. Close the burner swing door slowly allowing the refractory to compress under the hinge and along the surface of the door frame.
6. Install two of the 3/8" brass nuts and flat washers on the long bolts on the side of the door. Tighten evenly until the remaining four 3/8" brass nuts and flat washers can be installed. Continue to tighten all six nuts and washers until the refractory gasket is compressed evenly around the frame. Do not over tighten.

Replacing the Rear Turn-Around cover Refractory

CAUTION

Be sure electric power is off to prevent accidental burner firing.

1. Remove the jacket rear cover. Remove eight 3/8" brass nuts and flat washers. Remove the rear cover.

2. Remove the refractory by cutting and scrapping the refractory out of the cover. The refractory is glued into the cover in four spots. Scrap remaining glue and refractory off of the inside of the cover.
3. Place a small amount of high temperature adhesive on the inside of the cover in four spots to hold the refractory. Press the replacement refractory into the cover.
4. Replace the rear cover, flat washers and nuts. Tighten nuts evenly until refractory forms a tight seal around boiler frame.

Draining

A clean, properly maintained heating boiler should not be drained unless there is a possibility of freezing, unless the boiler has accumulated a considerable amount of sludge or dirt on the water side, or unless draining is necessary to make repairs. Very little sludge should accumulate in a boiler where little to no makeup water is added to a properly operating system.

Antifreeze

- Antifreeze solutions when used in heating systems should be of the ethylene glycol base type with an inhibitor added.
- Antifreeze concentrations should be not less than 33% no more than 66%. The service life of antifreeze depends on such factors as heating system design, hours of operation, aeration and rates of contamination. Therefore, the antifreeze solution should be tested at least once per year and as recommended by the manufacturer.
- Antifreeze solutions are harmful or may be fatal if swallowed, therefore antifreeze solutions should only be used in closed circulating systems.
- Antifreeze solutions expand more than water for a given temperature rise. Allowance must be made for this additional expansion when antifreeze solution is used in the heating system.

Fireside Corrosion

- Some fuels contain substances which can cause fireside corrosion. Sulfur, vanadium and sodium are among the materials which may contribute to this problem.
- Preventing this trouble from this source depends greatly on keeping the boiler heating surfaces dry. It is recommended to eliminate this problem that the boiler water temperature be maintained at 120 degrees F year round and that the input is adjusted that a minimum stack temperature of 400 degrees F is maintained.

Sealants

- Sealants may have a detrimental effect on boilers, pumps, relief valves, etc. and are not recommended to be used in hot water heating boilers.

END OF HEATING SEASON/SUMMER STORAGE

1. Turn off power to boiler and set aquastat or thermostat to "off".
2. Clean boiler and chimney thoroughly. See previous sections for details.
3. Spray interior of combustion chamber with light oil to protect against corrosion.
4. Separate electrical disconnect cord. Remove oil and air lines. Take burner to work bench. Clean burner nozzle, electrodes, head and other burner parts. Replace any worn parts as needed. Replace burner on boiler so it will be ready for next season.
5. Service oil tank screens and filters and screen in head of pump. Pump gaskets are fragile so have a spare gasket available.
6. Flush oil pump with #2 fuel oil or kerosene. Reassemble pump.
7. Drain water and sludge from fuel tank.

Start up procedures for the new heating season are the same as a initial start up. Following these tips will help assure a longer life of the boiler, and will be ready for the next heating season.

COLUMBIA LVWO WASTE OIL-FIRED BOILERS

Product Specifications

1. Boiler Construction:

1. Boiler shall meet EPA exemption guidelines for safe disposal (40 CFR 266) of used oil.
2. The boiler shall be ASME, I.B.R., approved and stamped to conform with the National Board of Boiler and Pressure Vessel Inspectors.
3. The boiler shell and tubes shall be designed for burning #1, #2 fuel oil, used crank case oils, used transmission, hydraulic and gear oils and any weight combinations up to SAE #50.
4. The cabinet shall be constructed of a minimum of 22 gauge steel with a heat and mar-resistant finish.
5. The boiler shall be of a Scotch Marine design.

2. Burner Construction:

1. U.S. and Canadian patented burner with slide out gun assembly providing a 36" oil preheat.
2. Burners shall be of the low pressure, air atomizing type using a thermostatically controlled combustion air and oil preheat gun assembly.
3. The burner oil gun must have an automatic pre and post flame purge cycle.
4. The preheat assembly shall prevent overheating and over-pressurization of both air and oil. This design must also limit internal carbonization and nozzle plugging associated with overheated fossil fuel mixtures.
5. Access shall be provided to easily remove the gun assembly and allow routine maintenance without removing the burner.
6. Burner shall be supplied to fire at the input rate specified.
7. Burner shall have a non-condensing exhaust.
8. Air for atomization must be designed to connect into an existing pressurized air source.
9. A quick disconnect cord shall be provided for electrical service to the burner.

3. Heat Exchanger:

1. Heat exchanger shall be of a shell and tube design.
2. Firing chamber shall be a welded construction with a minimum of 1/4" boiler plate.
3. Flame target area shall be refractory and shall be replaceable. Replacement materials shall be available.
4. The heat exchanger shall have welded tubes.
5. A swing out burner door and easily removed rear turn-around door shall be provided to allow easy tube cleaning maintenance.
6. Must have a flame inspection port for visual inspection of flame without opening door or disturbing draft.

7. Flue is 5" with a minimum 11 gauge connector.
8. Shall have a removable hinged burner mount for fire chamber access.
9. Shall have a minimum of (2) washouts.
10. Shall have available a 1 1/4" supply and 1 1/4" return water connection.

4. Controls:

1. Shall be provided with an Operating and High Limit Aquastats that are UL recognized.
2. Shall be provided with a Temperature/Altitude Gauge of 0-75 psi and 60-320° F.
3. Shall be provided with an adjustable Safety Relief Valve that is ASME listed for 535,000 BTU/H.
4. All burners will have cadmium flame sensors for positive, fail safe, combustion verification.
5. Burner shall have three indicator lights to monitor burner operation.
6. A thermostat provided by others.
7. An oil transfer pump shall be available to meet the following minimum requirements: 6 GPH @ 20 psi, minimum 1/4 hp heavy duty.
8. High range oil and air gauges shall be provided. These shall be interchangeable and capable of reading vacuum and pressure.
9. Hour meter shall be standard to record burn time.
10. Oil filter shall be provided with 100 mesh stainless steel, washable element. Must include a port for a vacuum gauge.

5. Warranty:

1. The fire chamber and heat exchanger shall have a (5) five year limited warranty. (See written warranty for more details.)
2. All mechanical parts and burner are covered the first year for full part replacement.

USED OIL-FIRED BOILERS SPECIFICATIONS SUMMARY

	MODEL LVWO
Waste Oil GPH (approx)	.75-1.5
Gross MBTU/H input (approx)	105-210/ hr
Water Volume in Shell, Gallons	8
Width w/o Controls	20"
Depth with Burner & Smoke Outlet	43"
Height	20"
Burner Model	B5 Single Nozzle
Weight (dry)	400
Shipping Weight (approx)	500
Agency Listing (Operation, Safety, & Performance)	ASME, IBR

BOILER ROOM REQUIREMENTS

- A. Room should be well lighted and should have a source of emergency light.
- B. Convenient water supply available for boiler and to clean the boiler room floor.
- C. Unobstructed floor drains.
- D. Since the combustion process requires a supply of air at all times, it is essential that provisions are made to supply adequate air to the boiler room. This air supply is necessary to insure complete combustion, a clean fire and to prevent nuisance shut downs due to excessively dirty burner parts. Air from the outside may be provided through ducts, fixed louvers or motorized louvers.
- E. Adequate space around the unit should be provided for inspection and service. We suggest 3 foot walkway for service.
- F. Do not allow your boiler room to become a "junk" room.
- G. Provide 3" thick concrete pad or blocks for boiler (optional) or place on non-combustible surface.
- H. Proper operation depends on adequate draft to maintain a negative pressure in the fire chamber. A commercial draft inducer is recommended.

UNIQUE CHARACTERISTICS OF BURNING USED OIL IN A BOILER

A. Accumulation of ash produces numerous adverse affects:

1. Reduced heat transfer (U.S. Bureau of Mines) Research by the U.S. Bureau of Mines has determined that 1/32-inch of soot coating causes 9.5% loss of boiler efficiency. The following table shows how soot thickness effects efficiency

1/32-inch of soot	9.5% loss of efficiency
1/16-inch of soot	26% loss of efficiency
1/8-inch of soot	45% loss of efficiency
3/16-inch of soot	69% loss of efficiency

2. Reduced air flow also causes incomplete combustion

Frequently Used Boiler Terms

BTU - British Thermal Unit, amount of energy to raise one lb. of water one degree F.

1000 BTU = 1 lb. of steam

34.5 lbs. steam/hr. = 1 boiler horsepower

240 BTU = 1 sq. ft. of steam

1 Gallon of #2 Oil = 140,000 BTU

1 Cu. ft. Natural Gas = 1,000 BTU

1 Therm. Natural gas = 100,000 BTU

150 BTU = 1 sq. ft. of hot water

1 Boiler hp = 140 sq. ft. steam radiation

34,500 BTU = 1 Boiler horsepower

1 Cu. ft. LP gas = 2,550 BTU

1 KWH = 3,413 BTU

BOILER CONTROLS AND SAFETY DEVICES

Safety Relief Valve. Setpoint @ 30 psi/ 535,000 Btu limit relief. Safety relief valves are not adjustable. Pipe on top of boiler in vertical position. Never reduce pipe size entering the valve. Pipe to floor drain in accordance with local codes.

Temperature/Altitude Gauge (temperature/pressure gauge). Factory mounted.

Operating Aquastat Honeywell L4006A: Operates burner to maintain boiler temperature at or below high limit set point and above low limit differential set point. A differential setting is provided to create a low temperature set point at which the burner will fire and bring the boiler back up to temperature. Set the high limit temperature at approximately 180° F and the differential at approximately 25°F. See the control manufacturer's installation and operating literature.

High Limit Aquastat with Manual Reset Honeywell L4006E: Shuts off power to the burner with the high limit set point is reached. Control must be manually reset to restart burner. Set the control temperature to approximately 20-25°F above the operating aquastat high limit set point to avoid nuisance tripping due to temperature over-shoot, after burner shutdown. See the control manufacturer's installation and operating literature.

Water Circulator (Optional)- used to circulate boiler water. Install as shown in piping diagram.

Items Not Provided: **Expansion Tank** - used to absorb expansion of water in the system when heating it. **Automatic Vent Valve** – removes air from the hydronic system automatically.

Basic Information for a Boiler System

Water [properly treated] is the most common fluid used in a closed loop hydronic system.

Other Fluids Used in Closed Loop Systems

- Glycol (antifreeze) is used in systems where below freezing or above boiling point temperatures may be reached.
- Propylene glycol - nontoxic and better heat transfer efficiency.
- Ethylene glycol - toxic and less heat transfer efficiency.
- An Inhibited (formulated to minimize corrosion) form of glycol is best choice.
- Oxygen in water leads to rust.
- 30% - 50% antifreeze is typical. Follow manufacturer's instructions.
- Galvanized piping is not desirable, use plastic, black, or stainless steels.

Circulating the Hydronic System

- Optimum comfort is obtained with constant circulation of water at a temperature just equal to offset the heat loss. This is obtained with 2-stage thermostats, a circulator, and

valves. This method is capable of reducing operating costs by 25% over simple on/off systems.

- Combustion and heat transfer is optimum when the system runs continuously, thus an oversized boiler will be slightly less efficient.
- Expansion/contraction (pipe stress) is minimized with continuous circulation.
- 80 to 100 degree F water may be circulated to the radiant floor. A floor too warm is uncomfortable thus the water temperature is kept to a minimum.
- Steel boilers can withstand thermal shock from cool return water but internal sweating could occur even when the burner is firing. Water temperature returning to the boiler of 140 degrees or greater is best.
- Controls and valving should be used to allow the boiler to operate as warm as possible and the circulating water in the floor to regulated to a lesser temperature.
- Circulator is a pump to move water through the boiler or associated process.
- Circulator should pump away from the expansion tank. Pumping toward the tank can lead to air problems by creating unwanted flows, pressures, or venting may occur.
- Circulators will last longer running continuously.

Expansion Tank

- Heating water causes it to expand, thus creating a need for an expansion tank.
- If the expanding water is trapped it will create unsafe pressures.
- Tanks should be rated 75 psi or greater.
- Two styles of tanks are available on the market: ***Diaphragm***, bladder inside that can be pressurized with air. Size this tank capacity to be 9 gallons for every 100 gallons of water in system. ***Non-pressurized tank***, basic open interior. Size this capacity to be 15 gallons for every 100 gallons of water in system.
- Antifreeze solution expands 20% more than water. Expansion tanks must be sized larger.

Indirect Storage Water Heating

- An auxiliary water storage tank, usually insulated, that simply stores hot water from the tankless coil. The boiler keeps this tank “ready” by re-circulating the water to the coils for reheating.
- Auxiliary water storage creates a larger volume of immediately available domestic hot water for the times when a coil would not be able to keep up on it’s own.
- It is a energy efficient system.
- Simple installation used with a boiler.
- Cost effective compared to installing a bigger boiler to meet demand.

Radiant Floor Heating

- Greater human comfort vs. forced air heating.
- Even air temperatures through elevation in room.

- Cleaner, no dust blowing. Used in paint shops and other dust sensitive areas.
- Concrete floor thermal mass allows quicker temperature recovery in heated space if doors or bays are opened frequently.
- Better zoning control.

Tubing for In-floor Heating

- Carries water to areas needing heat. Three styles are commonly used: ***Metallic***, soft copper typical. ***Synthetic***, rubber and plastics. ***Composite*** - laminates of metal and synthetic.
- Synthetic - most popular. Could be of rubber, polyethylene, or polybutylene.
- Oxygen Permeation - oxygen entering the circulating system through the tubing walls causes premature failure of components due to rusting. Tubing with oxygen barriers is available through contractors.
- Do not be thrifty on tubing, it can not be easily repaired or accessed if done incorrectly or is of a type that allows oxygen to enter the water loop.

Snow Melting

- Anti freeze solutions must be used in the circulation system going outdoors.
- A second heat exchanger should be used to keep the boiler water loop and ice melt (antifreeze) loop separate.
- Put a sensor in the outdoor concrete slab to keep the surface of the slab at 34 degree F.
- Snow or ice is unlikely when temps drop below 10 degrees F or are above 40 F so design the controls to give the boiler the day off.

For your safety switch off power supply before servicing.

TROUBLE – SHOOTING GENERAL

Burner Fails To Ignite

A flame requires three components: 1. fuel 2. spark 3. air .

Success will come from determining which are not present and how to fix them.

1. Check oil pressure, it should hold constant and not fluctuate or drift up and down.
2. Be sure a spray of oil is going into chamber, if not, find obstruction. Cleaning the nozzle, oil solenoid, or regulator may be required. A fine mist can look like adequate oil is being sprayed but there may be inadequate volume to establish a flame. Determine whether the fuel supply is combustible. Antifreeze, paint, or water may have entered the oil lines.
3. Check oil filters in line. All filters in the oil line need to be checked and cleaned periodically. They will become blocked with continued use and slowly restrict oil flow.
4. Inspect check valve to see if they open as expected and in the proper direction. Check strainer in the oil tank for dirt. Check strainer in pump head for blockage but have replacement head gasket available as the gaskets are fragile.
5. Check for spark at electrodes. Check for proper gap, for shorting to nozzle or head. Be sure igniter is receiving power and creating voltage for a arc. Electrode tips should be free of carbon and ash buildup. Tips should diverge to fan the arc over the nozzle.
6. Check air pressure and volume in supply line. Starting pressure should be about 13 PSI but not fluctuate wildly or drift up and down. A falling air pressure or inability to adjust to 25 psi at the burner's regulator can indicate inadequate volume of air supply.
7. Check for condensation in compressed air line. Air solenoid could be sticking or air proving switch stuck in open position. This would keep power from igniter, burner motor, and oil valve. Indicator would be green light does not come on.

Fluttering Or Pulsating Flame

1. Vacuum leaks in oil pump or suction line. A dancing gauge pressure is good indicator.
2. Excessive combustion air or damaged, abnormal shaped retention head.
3. Dirty or plugged fuel filter. Dancing or low vacuum pressure is good indicator.
4. Nozzle or adapter o-rings in nozzle assembly defective, allowing bypass. If adjusting burner's air regulator pressure up and down between 5 and 25 psi will cause oil pressure to change with it the o-rings may not be sealing.
5. Water or antifreeze in the fuel. Confirm the fuel is combustible and consistent.
6. Condensation in the compressed air supply not delivering consistent air volume.

Flame Failure

1. Obstruction in nozzle, air or oil solenoid, or air or oil regulator - clean or replace. Having to operate at higher than normal pressures is indication.
2. Fuel pump not operating, coupler loose, bypass in pump stuck open.

3. Water, paint, or antifreeze in oil.
4. Failure of pre-heater(s) in slide gun assembly. Slide gun underside should feel warm.
5. Electrodes improperly adjusted, broken, shorting, or ash covered.
6. Centrifugal switch in burner motor failing (green light flickers or will not come on).

Primary Control Locks Out On Safety

1. The cad cell (electronic eye) detects a reduced, dirty or no flame for over 30 seconds. A signal measured in ohms is communicated between the cad cell and the primary control “F – F” connections. A poor or absent flame produces a high ohm reading. When this signal is > 1500 ohms the control goes into reset. A signal indicating a very good flame is < 500 ohms. A moderate flame would be 500 to 1000 ohms. Contact your dealer for details on reading ohms at the safety control.
2. The cad cell has failed, lens is dirty, or retention head is dirty.
3. The retention head fins are not allowing light to pass to the cad cell.
4. The cad cell receptacle is not making good contact with the cell.
5. The primary control is defective allowing the reset button to pop too easily.
6. Exhaust fan in building reverses draft in chimney, or cold building at night creates down draft. The flame smokes on startup due to lack of proper draft and trips reset.

Smoke On Ignition

1. Oil flow too great--adjust flow downward.
2. Air pressure too low (set approximately 13 psi and adjust as needed).
3. Down draft, or improper draft adjustments, check barometric damper regulator. Install a draft inducer if reverse draft is present due to cold building or exhaust fans.

Poor Draft

1. Confirm there is -.02 to -.04 inches water column at breech of exchanger.
2. Firebox, flue outlet, or stack is plugged with ash.
3. Exhaust fan in building reverses draft in chimney.
4. Cold building at night creates down draft in chimney.
5. Height of chimney insufficient or pipe cap plugged or blown off.
6. Lack of make up air for combustion.
7. Install a draft inducer if reverse draft is present due to cold building or exhaust fans.

PARTS LISTING

B (SLIDE GUN COMPLETE)

E L I N J S

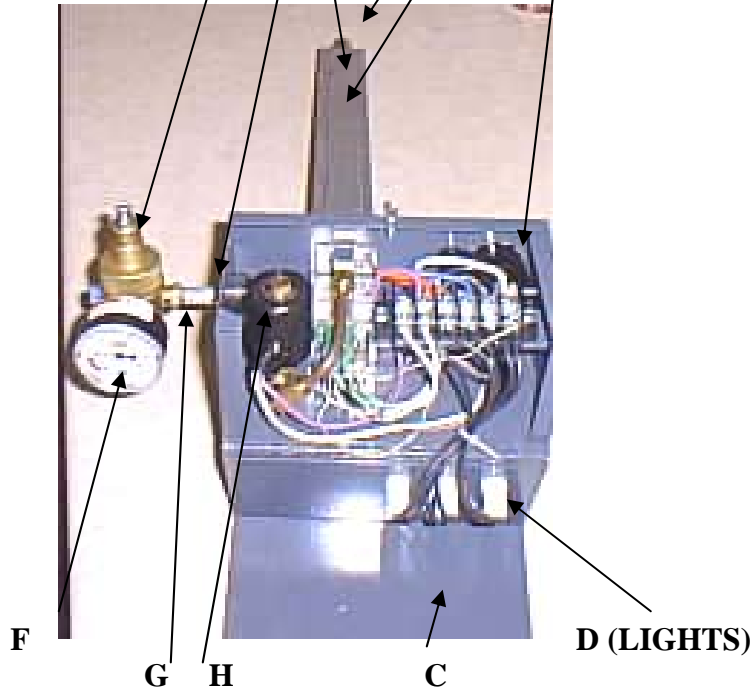

M K O P Q R

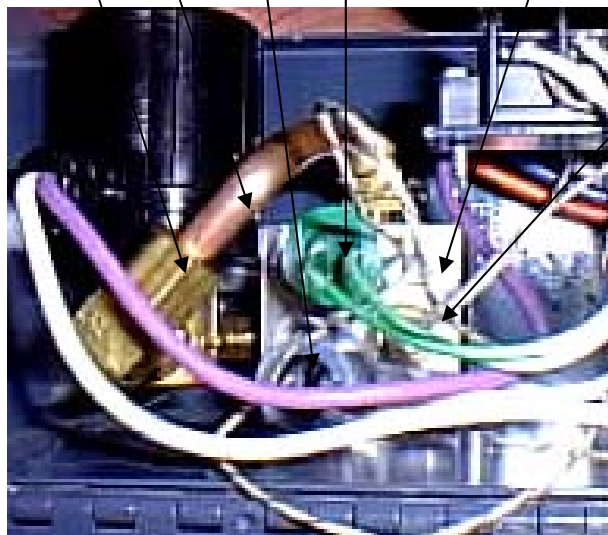

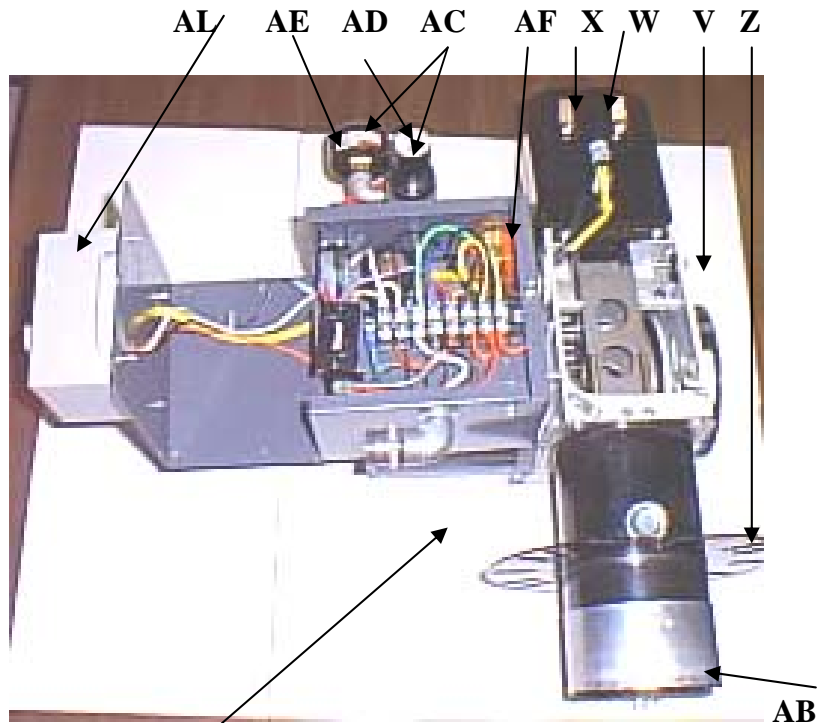

A (BURNER COMPLETE)

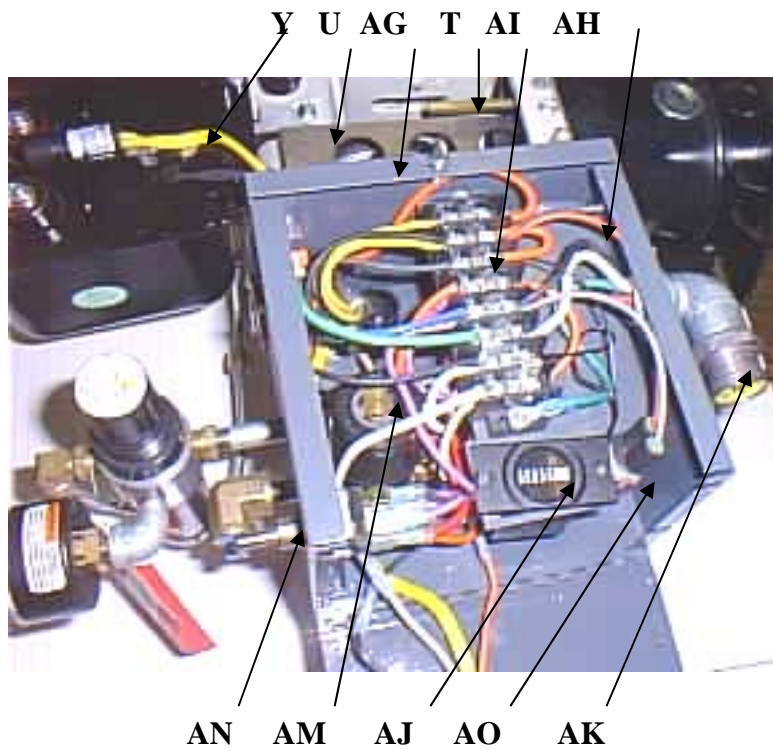

USED OIL FIRED BURNER

Key	120V/60 HZ			Description
A	56030			B5 Burner Complete, 235 KBTU
B	56905			B5 Slide gun Assembly Complete
C	56906			B5 Oil Control Box , Metal Housing Only
	57118			6 Pole Terminal Strip
D	57120			Amber Control Light
	57212			Green Control Light
	57122			Oil Regulator and Gauge (#60)
E	57130			Oil Regulator Only
F	57129			60 Pound Vacuum/Air Gauge
	57144			#8 x ½ HEX Washer Head TEK Screw
G	57197			1/8 x 1.4 Male Brass Bushing
	57198			Diaphragm for Norgren Oil Regulator
	57127			Regulator Seat Gasket
	57111			Oil Regulator Flow Seat (Large Hole
H	57190			Oil/Air Solenoid
I	57175			B5 Aluminum Preheat Block with Plugs
J	57178			1/8 NPT Steel Plug with Vibraseal
K	57195			¼ copper Tube – 4 Inch
L	57196			1/8 x 3 1/5 inch Galvanized Nipple
M	57206			1/8 x ¼ Compression Nut and Sleeve
N	57103			Nozzle #9-1
	57107			Nozzle #7-3
	57105			Nozzle #9-5
	57177			B5 Nozzle Retainer Plate with Screws

Key	120V/60 HZ			Description
	57181			8-32 x ½ socket head Screw for Retainer Plt
	57186			O-Ring for Nozzle
	57179			Nozzle Adapter Brass with Both O-Rings
	57184			O-Ring for Nozzle Adapter (Small)
	57182			O-Ring for Nozzle Adapter (large)
O	57146			Temperature Sensor, 140 Degrees
P	57149			Temperature Sensor, 160 Degrees
Q	57160			Heater Element, 130 Watt
R	57165			Heater Element, 300 Watt
S	57172			Male Electric Plug
T	57110			Electrodes (set of 2)
	56921			Electrode Clamp
U	56920			B5 Sleeve Support Assembly for Block
V	57189			B5 Burner Housing Only
W	57222			Transformer- Webster
	56991			Buss Bars w/ Extensions & Screws (set of 2)
X	56989			Buss Bars (set of 2)
Y	57209			Cadmium Cell, 60" Leads, Honeywell
Z	57205			B5 Air Tube with Flange
AB	57116			B5 Stainless Steel Flame Retention Head
	57204			B5 Blower Wheel
	57220			B5 1/7 HP Motor for Burner
	56974			B5 Air Inlet Restrictor Disc w/ Blots,
	52321			B5 Air Shutter for Burner, Has Pointer Finger

Key	120V/60 HZ			Description
	57280			Rubber Grommet
AC	57140			Air Regulator & Gauge
AD	57156			Air Regulator
	57143			Bowl Assembly for Air Regulator
	57157			Filter Element for Air Regulator, White Stone
AE	57144			-30 to 60 psi Combo Gauge
AF	57176			Female Electric Plug
AG	56913			B5 Air control Box Metal Shell Only
	56932			Support, Air control Box
	57281			Rubber Grommet for Air Control Box
AH	56967			Air Pressure Tank
	57199			1/8 NPT Sale Brass Hex Nipple
AI	57119			8 Pole Terminal Strip
	57193			1/8 NPT Male Swivel Adapter
AJ	57214			Hour meter
	57215			Hour Meter Bracket
AK	57235			Quick Disconnect Cord, Burner End, Male
	57240			Quick Disconnect Cord, Junction Box End, Female
AL	57207			Primary Control
	57194			O-Ring for Combu Solenoid Base
AN	57169			Toggle Switch for Oil Prime
AO	57170			Air Proving Switch
	57174			Metal Air Line with Fittings
	57211			1/8 NPT x 1/4 Comp. Elbow w/ Nut & Sleeve
AM	57190			Solenoid for Oil or Air
	57192			Plunger, Zinc Plated w/ Spring
	57139			Plunger, Nickel Plated w/ Spring and Spacer

	57212			1/8 Brass Street Elbow
--	-------	--	--	------------------------

Key	120V/60 HZ			Description
	57213			1/8 Galvanized Street Elbow
	56400			Screen Suction Strainer 3/4 in.
	56405			Check Valve 3/4"
	57155			Lenz Oil Filter Asm (100 mic) with Gauge
	57151			Lenz Replacement Element with O-ring
	57153			Lenz O-Ring (between head and housing)
	15711			Ball Valve, 1/2 NPT x 1/2 NPT (install filter)
	57263			Flare Ball Valve, 1/2 FNPT x 3/8 (install at oil regulator)
	56680			Swivel, 1/2 x 1/4 (install at oil regulator)
	56681			Swivel, 3/4 x 1/2 (install at Lenz filter)
	56683			Tee, 1.4 x 1/4 x 1/8
	56685			Hex Nipple, 1/4 x 1/45 (install at oil regulator)
	56686			Hex Nipple, 1/2 x 2 (install at Lenz filter)
	56688			Nipple, 1/4 x 2
	56925			J-Oil Pump Assembly; Motor, Base, Pump Head
	56934			J-Oil Pump Only less Motor and Housing
	56923			Gasket for J-Oil Pump Cover
	56930			1/4 HP Motor only for J-Oil Pump,
	57261			Coupler for J Oil Transfer Pump
	57262			Shaft Seal; J-Oil Pump <u>Face</u> (no snap ring)
	57259			Shaft Seal; J-Oil Pump <u>Lip</u> (has snap ring)

Key	120V/60 HZ			Description
	56418			Wall Thermostat, 24 Volt ac
	57144			Lenz 60# Vacuum/Air Gauge

Maintenance Record

Date Service Performed Signed

